

Beam Elements

Are they precise ?

Dr.-Ing. Casimir Katz

FENet Technology Workshops,
October 2004, Glasgow, Scotland.



Cable Analysis

Cable

$$-H w''(x) = p(x)$$

Solution for uniform load is a quadratic parabola or a sinh

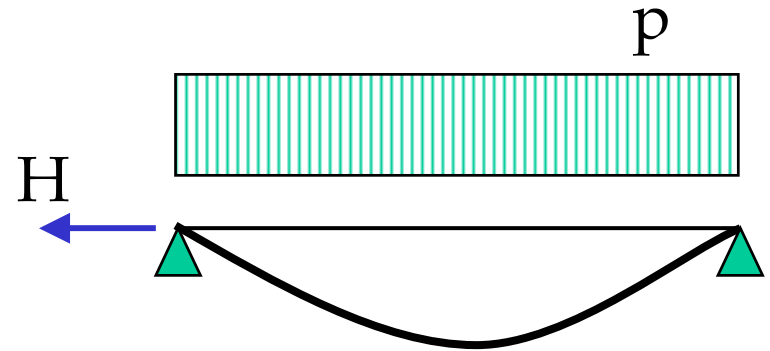

Cable element

Linear between the nodes
Solution space: polygonal

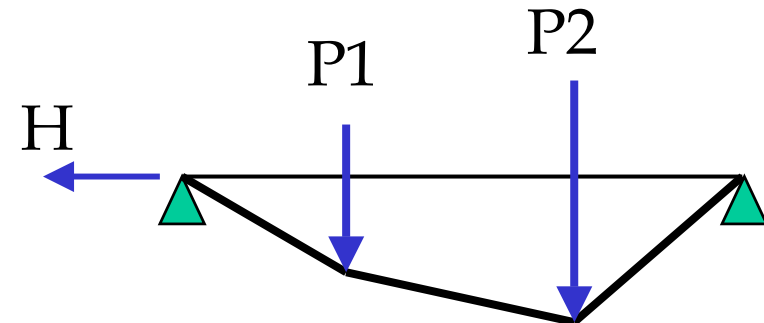

Cable Analysis

- Solution Space
$$w_h(x) = w_1 j_1(x) + w_2 j_2(x) + \dots$$
- Solution is exact for:
 - Single forces
- Other loadings:
 - Minimum of energy => equilibrium
- Exact solution is obtained in the nodes!
 - Why ?

Green's Functions

- The influence function (Green's function) for the deformation of the cable at a point is the cable polygon created by a point load $P=1$ at the point of interest.
- If the FE-System is able to model this solution exactly, the solution will be exact for this value.
- In all other cases, i.e. if the Green's function is not within the possible solution space, one has an approximate solution only.

What are Beam Elements ?



- A 3D Continua with a length \gg width / height
- Simplification of the solution space
(Bernoulli-Hypothesis, persistence of shape)
- Simplification for manual analysis
(gravity centre, principal axis, shear etc.)
- Superstition:
 - Beam elements are simple
 - Beam elements are exact

Problematic continuous beam

- Mechanic is not consistent

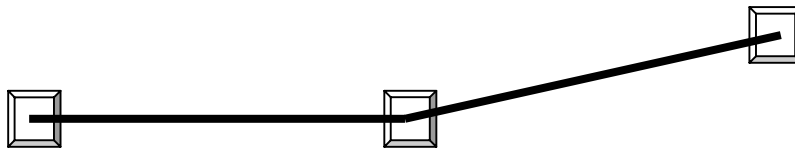

Plan view



Moments

Sections

- Normal stress

$$u = u_0 + \varphi_y z - \varphi_z y$$

$$\sigma_x = E \varepsilon_x = E \frac{\partial u}{\partial x} = E \left[\frac{\partial u}{\partial x} + \frac{\partial \varphi_y}{\partial x} z - \frac{\partial \varphi_z}{\partial x} y \right]$$

Sections – Shear Stress

- V is only valid if the normal force and the section are constant along the axis
- Z is only valid if the section is not multiple connected
- The shear stress is not necessarily constant along the width b
- For biaxial bending or non effective parts of the section, the equation becomes more complex (Swain's formula)

$$\tau = \frac{V}{I} \frac{Z}{b}$$

An other strategy: a deformation method

$$\tau_{xy} = G \left(\frac{\partial w}{\partial y} - z \frac{\partial \Theta_x}{\partial x} \right)$$

$$\tau_{xz} = G \left(\frac{\partial w}{\partial z} + y \frac{\partial \Theta_x}{\partial x} \right)$$

$$G \Delta w = G \left(\frac{\partial^2 w}{\partial y^2} + \frac{\partial^2 w}{\partial z^2} \right) = - \frac{\partial \sigma_x}{\partial x}$$

Boundary Conditions :

$$\tau_{xy} n_y + \tau_{xz} n_z = 0$$

Unit Warping

QUP (V11.05-21) 24.10.2002

SOFiSTiK AG, 85764 Oberschleißheim, Bruckmannring 38, Tel:089/315-878-0

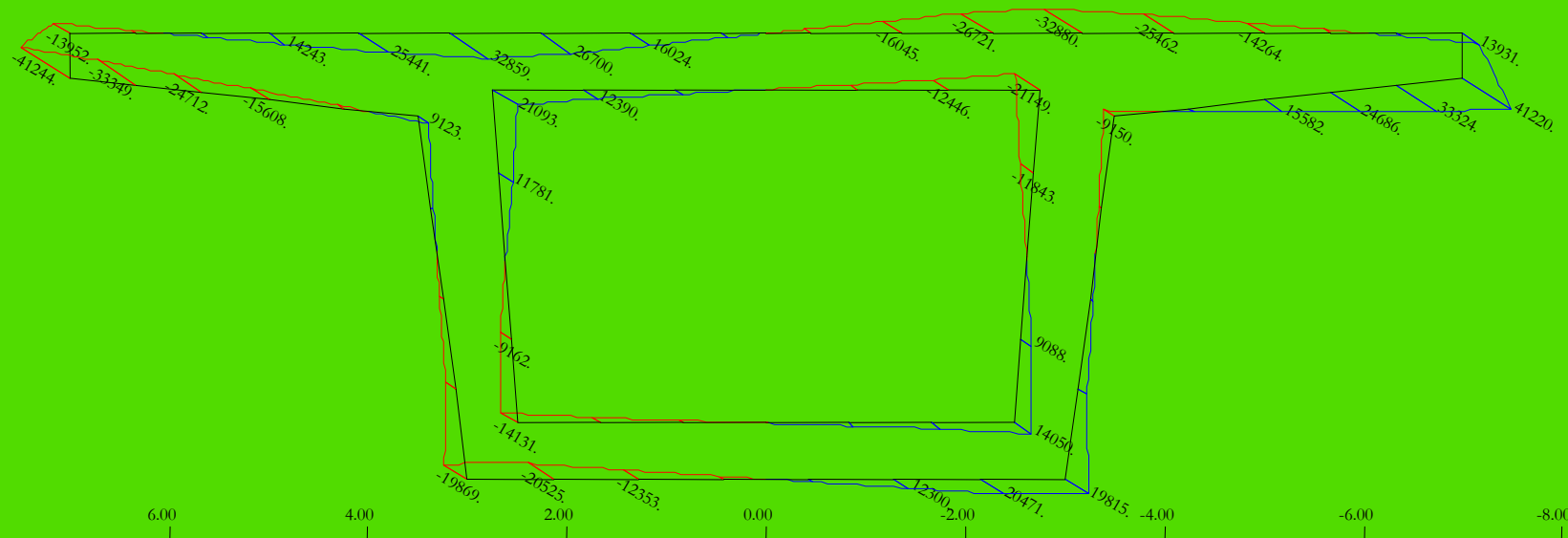

Querschnitt Nr 12 Vollquerschnitt
Verwölbung 1 CM = 50000.000 [cm²]

M 1 : 0

Shear stress from Mt

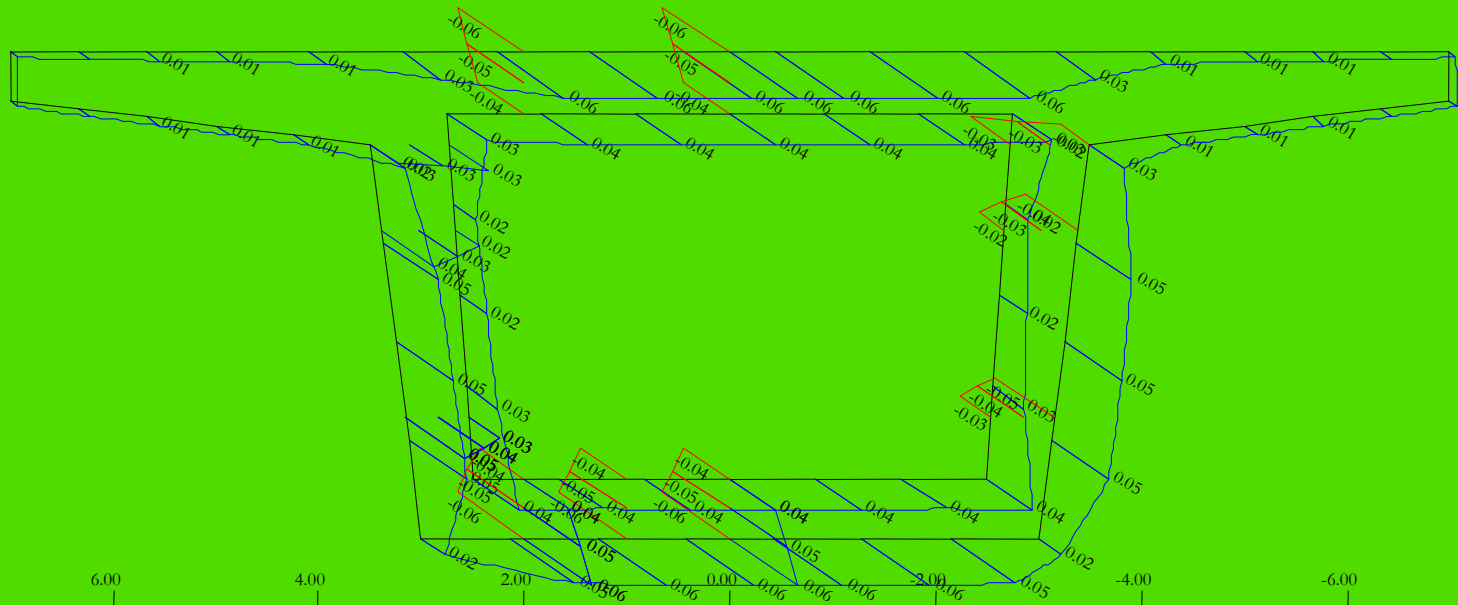

Querschnitt Nr 12 Vollquerschnitt
Schub aus MT=1000.00 1 CM = 0.05 [MPa]

Shear stress from Vz

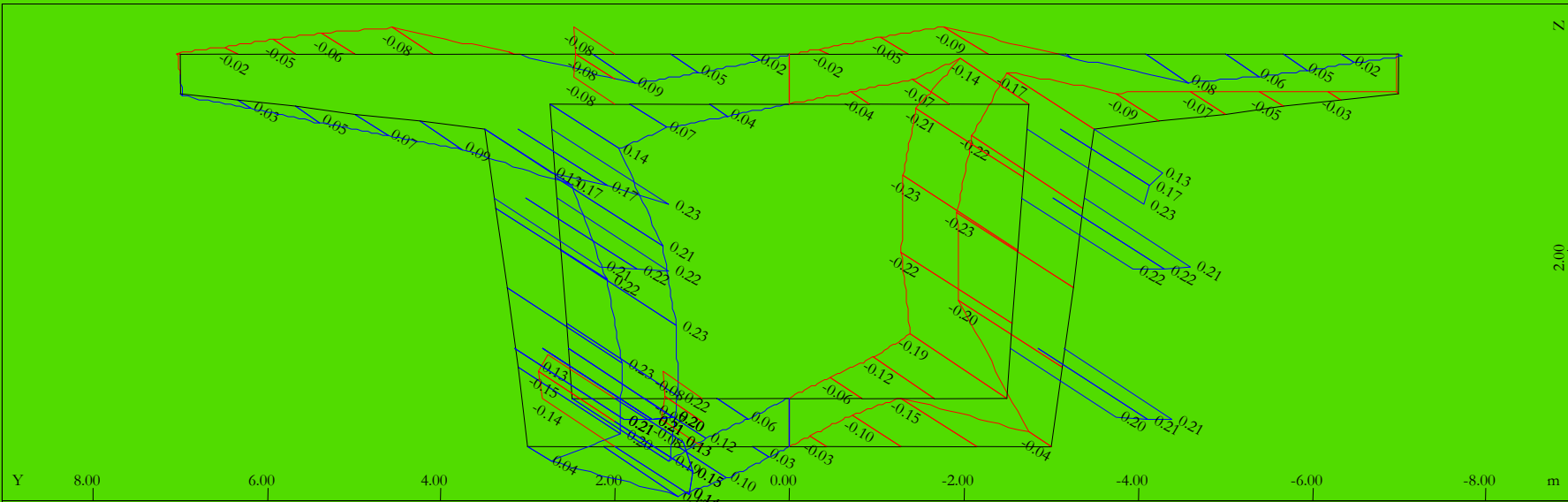

Querschnitt Nr 12 Vollquerschnitt
Schub aus Vz=1000.00 1 CM = 0.10 [MPa]

Shear deformation

- Theory of Timoshenko/Marguerre (not exakt!)

$$\Theta_y = \frac{V_z}{G A_z}$$

$$\varphi_y = \frac{\partial w}{\partial x} + \Theta_y$$

- Principal Axis of shear deformation

$$\begin{bmatrix} \Theta_y \\ \Theta_z \end{bmatrix} = \begin{bmatrix} \frac{1}{GA_y} & \frac{1}{GA_{yz}} \\ \frac{1}{GA_{yz}} & \frac{1}{GA_z} \end{bmatrix} * \begin{bmatrix} V_y \\ V_z \end{bmatrix}$$

Shear in haunched beams

$$p = 10 \text{ kN/m}$$

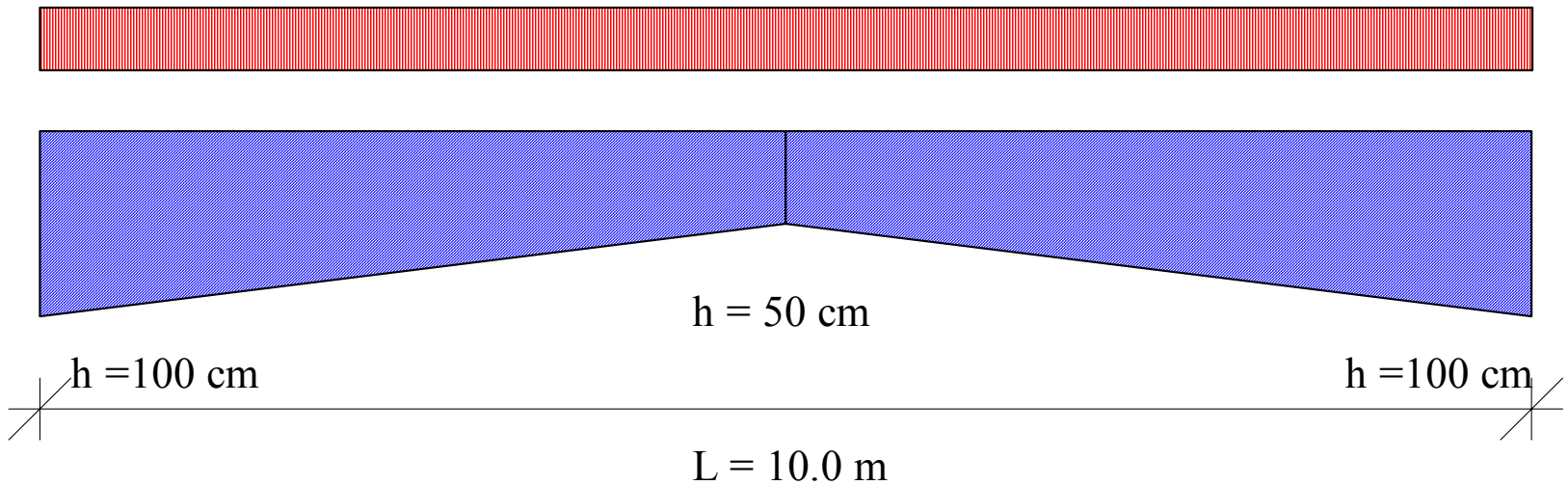

FE-Analysis

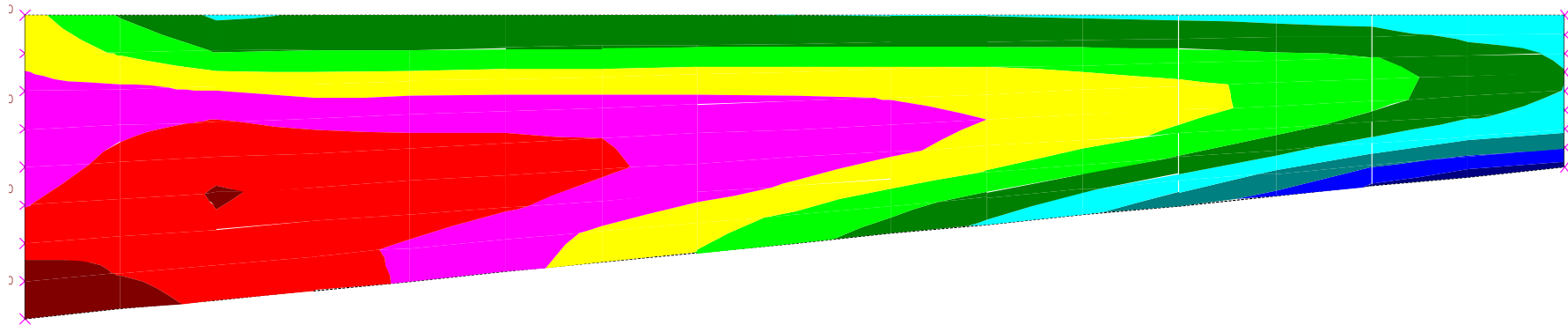

τ_{xy}

FE-Analysis

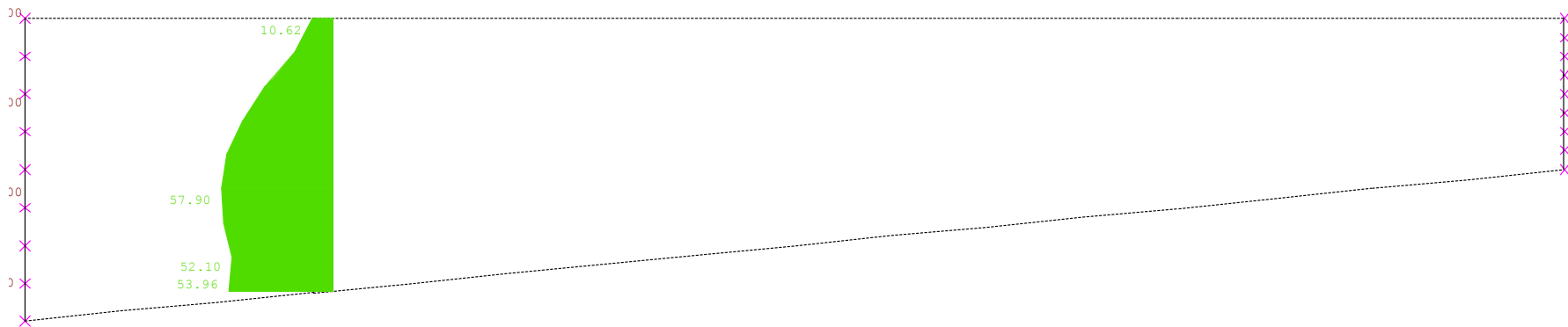

tau-xy in vertical section

Shear in haunches

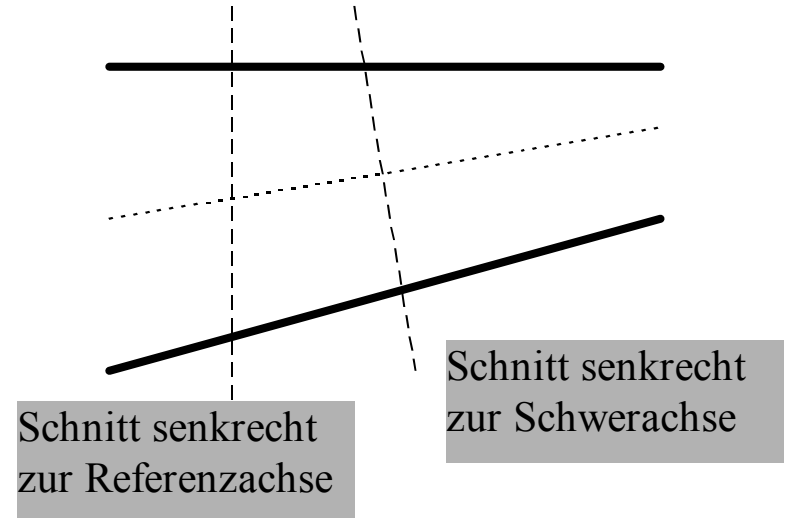
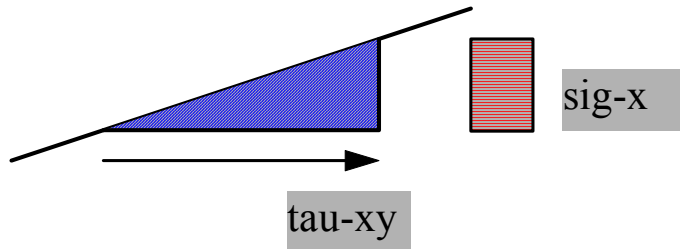

FE-Analysis

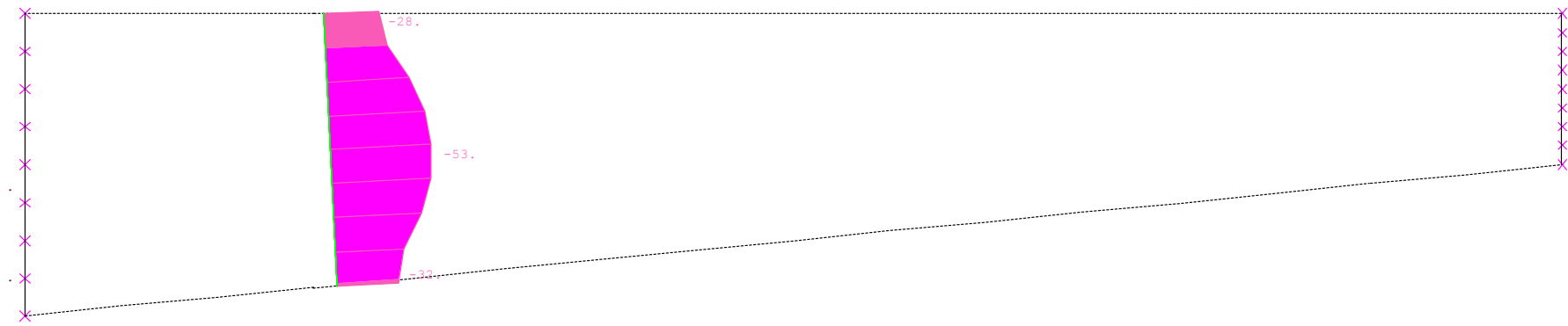

tau-nq in perpendicular section

Shear in haunched beams

- Example for a shear reduction along the provisions of design codes
 - Shear force V 40.0 kN
 - Yielding a faulty shear stress 63.2 kN/m²
 - Reduction of shear by $M/d^* \tan\alpha$ 5.6 kN
 - Reduced shear stress 54.9 kN/m²
 - FE-shear stress 53.0 kN/m²
- Although the engineering approach has a completely different view, the maximum stress is quite good, distribution is faulty however.

FE of a haunched beam

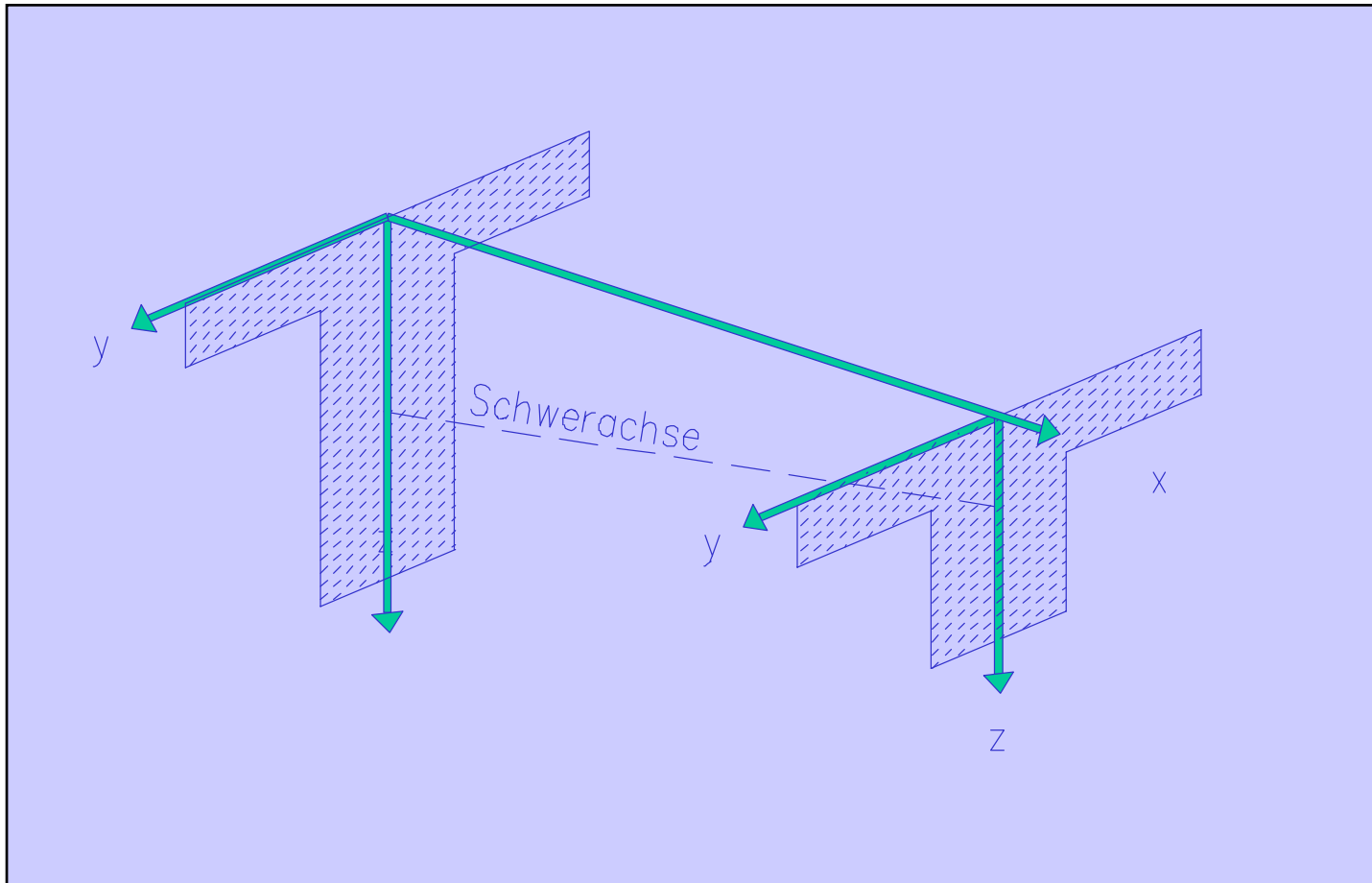

Reference of forces ?

- Gravity axis with $N + V$
 - Results suited for design
- Gravity axis with $D + T$
 - Similar as for 2nd order Theory
 - Superposition of forces
- General reference axis
 - Superposition of forces if a composite section changes by in situ concrete or tendons.

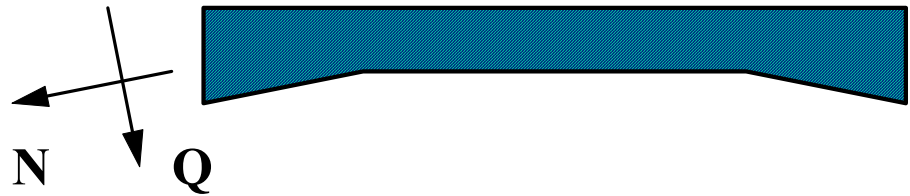

Principles of the FE-Beam

- Excentricities at the end points

$$u_{0i} = u_i + \varphi_{yi} \Delta z_i - \varphi_{zi} \Delta y_i$$

$$u_{0j} = u_j + \varphi_{yj} \Delta z_j - \varphi_{zj} \Delta y_j$$

- Interpolation u_0 linear, $v, w, \varphi_x, \varphi_y$ cubic
- Displacements within section

$$u = u_0 + \varphi_y (z - z_s) - \varphi_z (y - y_s)$$

- Strains from derivative (position of gravity centre is not constant!)

$$\varepsilon_x = \frac{\partial u}{\partial x} = u'_o + \varphi'_y (z - z_s) - \varphi'_z (y - y_s) - \varphi_y z'_s + \varphi_z y'_s$$

Example of a haunched beam

$$p = 10 \text{ kN/m}$$

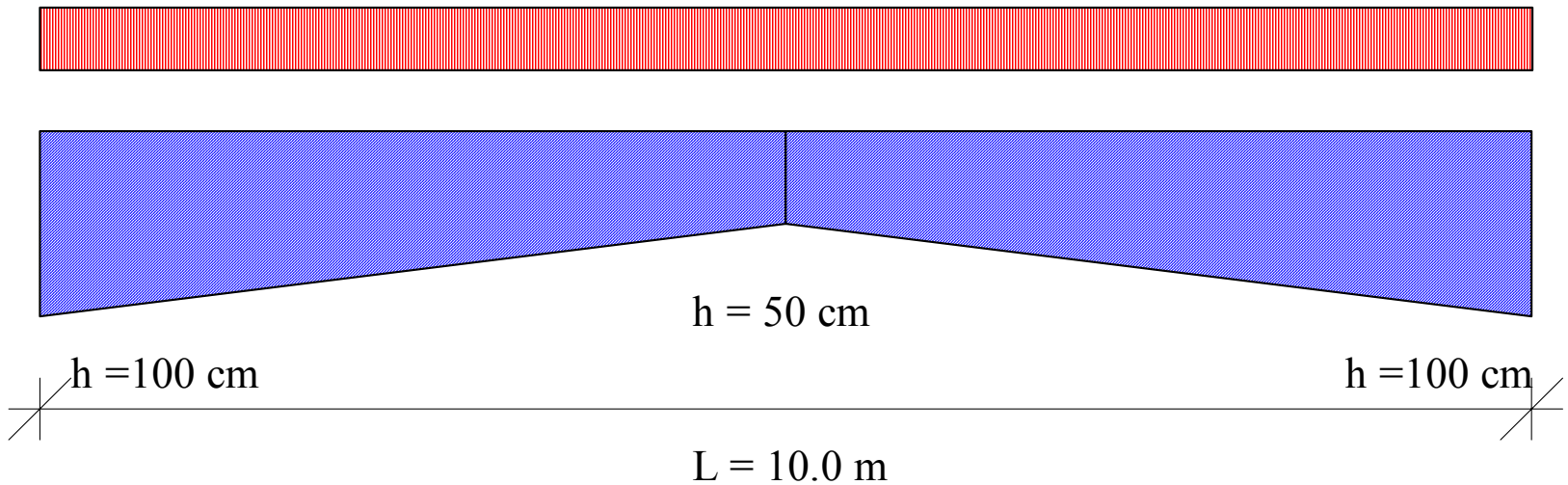

Results for haunched beam

	w[mm]	Ne[kN]	Nm[kN]	Mye[kNm]	Mym[kNm]
Inclined axis					
C-Beam (1 element)	0,397	-80,50	-78,00	-73.58	31,91
C-Beam (8 elements)	0.208	-46,30	-43,80	-94,87	19,17
FE-Beam (1 element)	0,172	-39,80	-37,30	-93,65	22,00
Fe-Beam (8 elements)	0.206	-45,80	-43,30	-95,02	19,14
Horiz. reference axis					
FE-Beam (1 element)	0.168	-37,90	-37,90	-93.01	22,52
FE-Beam (8 elements)	0.204	-44,20	-44,20	-94.85	19,10

- 37 . 8 8

- 37 . 8 8

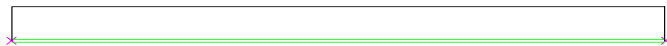

- 93 . 0 1

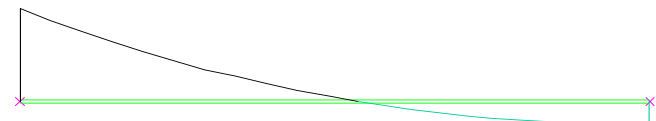

The precision of the FE beam (bending)

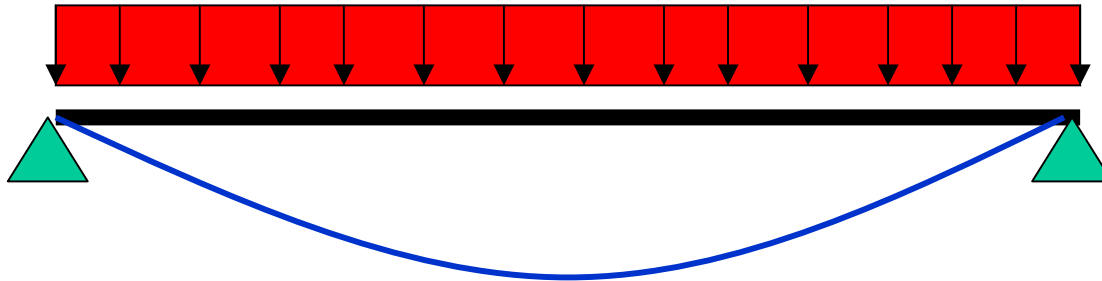

	Exact	1 Element	2 Elements
Max. Moment	281.25	281.25	281.25
End Rotations	41.147	41.147	41.147
Cent. deflection	19.2876	15.4301	19.2876

Bending precision

- The theoretical solution is a polynomial of 4th order
- The shape functions are cubical splines The highest symmetric ansatz function is the quadratic parabola
- As the influence function for the nodal displacements are cubic functions, the deformations and rotations in the nodes are exact.
- The moments and shear forces are also exact.
- The only values which are not are the displacements between the nodes (which are of less interest)
- For a buckling analysis there are the same principles, but know the buckling force (which has a high importance!) is not ok for a simple element.

The precision of the FE beam (Buckling analysis)

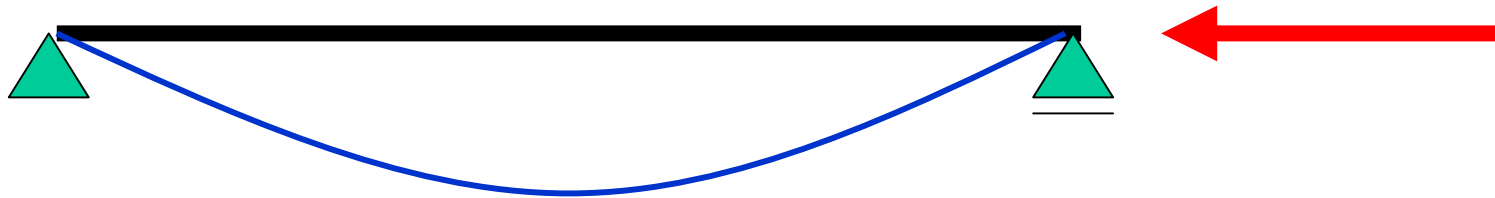

	Euler II Exact	Euler II Numerical	Euler IV Exact	Euler IV Numerical
1 Element	13312	16065	52848	-
2 Elements		13312		53550
3 Elements		13219		53249
4 Elements		13213		52879

Warping Torsion and Shape deformation

- > 6. Degrees of freedom per node
- More forces and moments:
secondary torsional moment M_{t2} etc.

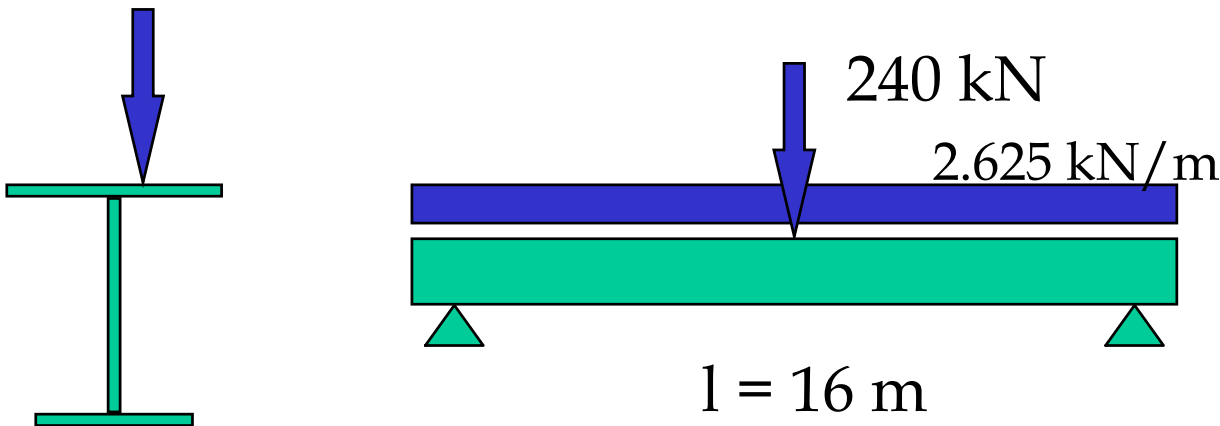

- Pure bending $\sigma = 84.3 \text{ N/mm}^2$
- Warping / 2nd Order Torsion $\sigma = 136.1 \text{ N/mm}^2$

Conclusion



- Beam elements are not simple in theory
- Beam elements are easy to use
- There are a lot of modelling errors possible